

## Mathematical model of integrated thermal apparatus

*Imrich Košťal<sup>1</sup>, Ján. Spišák, Ján Mikula and Katarína Mikulová Polčová*

*Mathematical model for the integrated thermal apparatus was developed. It consists of program modules from which individual furnace model can be generated. For the model generation elementary balance method was used. Generation of the individual model includes model formulation and parameters determination. Model formulation is based on first principles, heuristics and empirical results. Parameters determination is generally based on priory information, but it has to take into account specific conditions. The developed model was adapted for real time applications. For quantitative application developed model has to be calibrated. For the calibration the operational furnace can be used. For model calibration of not existing furnace the priory knowledge and physical model can be used. Presented model was calibrated on experimental furnace. The results were gained by simulations.*

**Key words:** mathematical model, elementary balance, granular materials, integrated thermal apparatus

### Introduction

Granular materials thermal treatment is connected with rheological, hydromechanical and thermodynamical limitations which implicate its low effectiveness and efficiency. Presently classical thermal apparatus as rotary furnaces, shaft furnaces, and fluidised bed furnaces have been used. Their possibilities have been almost exhausted and they improvement has generally not decisive technological, economical and environmental impact. In the last years new technologies in the area of granular materials thermal treatment have emerged: integrated thermal apparatus, microfluid furnace, and high revolution furnace (Fig. 1). For all of this technology is characteristic high intensity of heat transfer, which enables significantly increase specific volume capacity and decrease fuel consumption.

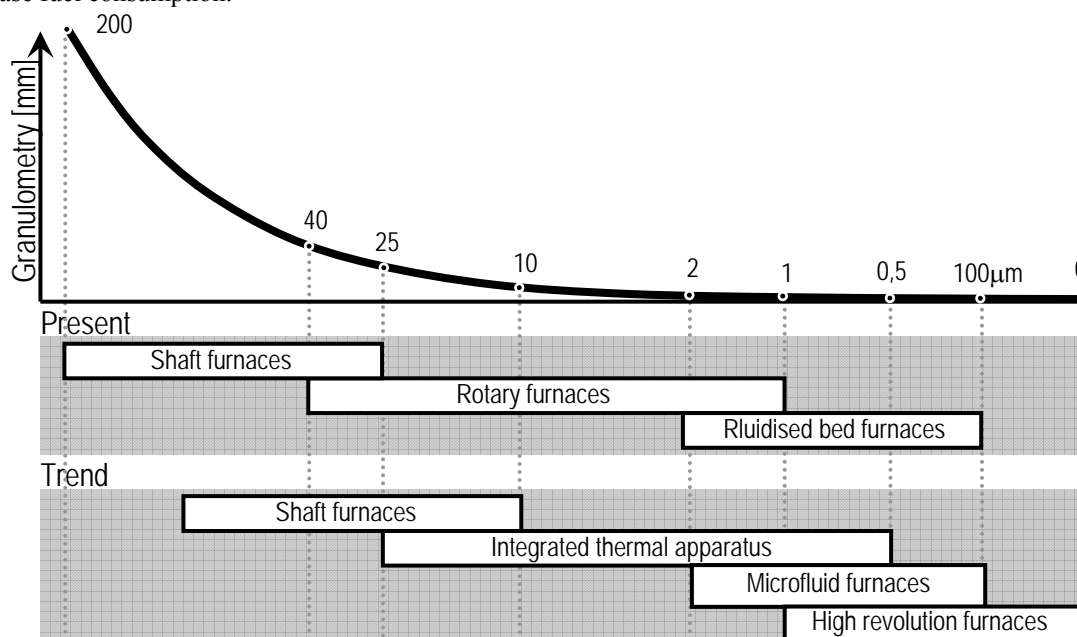

Fig. 1. Furnaces for granular materials thermal treatment.

Basic improvement is in significant increasing of heat exchange area, heat distribution and in hydrodynamics. Development and operation of this thermal apparatus is based on physical and mathematical modelling, which can significantly contribute to acquire required critical knowledge. Generated models can be used for simulations at elementary and higher levels. They have been adapted for real time simulation. One of the critical requirements is speed of calculations.

<sup>1</sup> prof. Ing. Imrich Košťal, CSc, doc. Ing. Jan Spišák, PhD., Ing. Jan Mikula, PhD., Ing. Katarína Mikulová Polčová, PhD., Technical University of Kosice, Development and realisation workplace of raw materials, Nemcovej 32, 040 01 Kosice (Review and revised version 12. 12. 2010)

## Mathematical models

### Generation of hierarchical simulation models

For mathematical modelling very generally simplified approaches are used [5, 8]. A mathematical model is based on the similarity between the real and the abstract system [9]. Developed mathematical models represent the modelled objects horizontally and vertically. Vertical models includes models interconnections on different discrimination levels. Transition on the higher hierarchical levels is connected with exponential decreasing of objects and of proportional simulation time decreasing. Objects on higher hierarchical level represents aggregation or abstraction of objects on the lower level. Simulations can be executed on the different levels. Transition on lower levels means increasing of discrimination ability. Discrimination levels include process foundations.

Hierarchical models generation includes objects decomposition and them responding processes for individual hierarchical levels. Models of processes on given hierarchical levels can be according to the process nature mutually independent or constitute aggregation or abstraction of models on the lower hierarchical level. Presently there is an existing large scale of models created for individual hierarchical levels. Their mutual interconnection is usually solved for specific situations. Presented modelling system includes production line, technological aggregate, aggregate parts, processes and parts of processes are discriminated (Fig. 2).

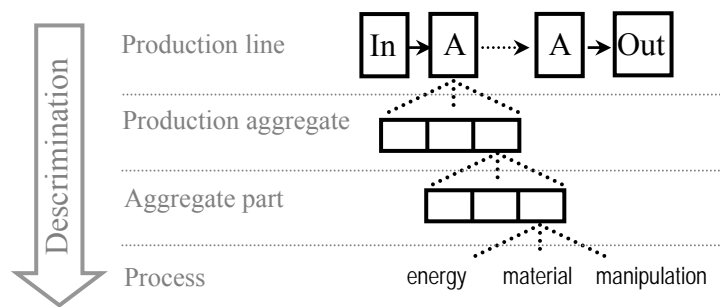

Fig. 2. Hierarchical decomposition of simulation models.

### Processing modules selection

Formally the simulations model consists from processing modules imitating the individual processes. At the processing modules selection level the processing modules and their interconnections are specified. Then adequate processing modules are selected from the model library. Model library contains the following models of:

- Transfer processes,
- Heat conduction and convection,
- Mass diffusion and convection,
- Heat and mass accumulation,
- Transformation processes,
- Heat generation by combustion,
- Evaporation and condensation,
- Carbonate dissociation.

Model represents aggregate decomposed on zones which have equal parameters, for example, equal fuel input, or layer thickness. Each zone is decomposed on layers which consist from elements (Fig. 3). Material and thermal balance is executed for each element (Kostial, 2006).

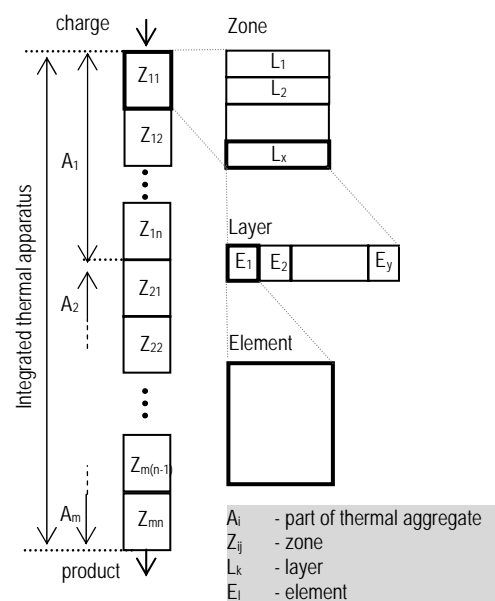

Fig. 3. Hierarchical decomposition of simulation models.

By combination of zones arrangement, their parameters and media flows great quantity of simulation alternatives can be created. The outputs from the created model can be used for surrogate models generation. Processes in the element runs by mutual interaction material and gaseous media (Fig. 4).

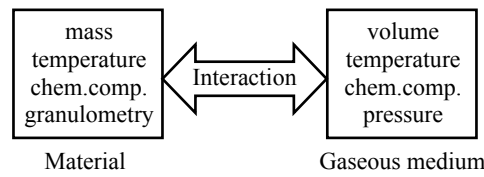

Fig. 4. Interaction between material and gas media in the element.

For model of the element regarded are processes of combustion, heating and cooling, drying and condensation and calcinations. At executed processes material and heat balance is preserved.

The sought quantities are calculated from mass and heat balance equations.

Mass balance for the element:

- material:  $m_{ml} - m_{er} = m_{mO}$  [kg.s<sup>-1</sup>]
- gas:  $m_{gl} + m_{er} = m_{gO}$  [kg.s<sup>-1</sup>]

where  $m_{ml}$ ,  $m_{gl}$  is mass of the material and gas input;  $m_{er}$  is mass transferred between material and gas;  $m_{mO}$ ,  $m_{gO}$  is mass of the material and gas output.

Heat balance for the element:

- material:  $Q_{ml} + Q_t - Q_{er} = Q_{mO}$  [W]
- gas:  $Q_{gl} - Q_t + Q_{gc} + Q_{mer} - Q_{hl} = Q_{gO}$  [W]

where  $Q_{ml}$ ,  $Q_{gl}$  is the physical heat of input material and gas;  $Q_t$  is heat transferred between gas and material;  $Q_{gc}$  is the heat generated by gas combustion;  $Q_{er}$  is the heat of endo or exothermic reactions (water vaporization, carbonate dissociation etc.);  $Q_{mer}$  is the physical heat of reaction products;  $Q_{mO}$ ,  $Q_{gO}$  is the physical heat of output material and gas;  $Q_{hl}$  represents the heat losses to the element surrounding.

### Modelling of basic processes

The elementary balance method has been used for modelling of thermal processes. Regarded is technological process at which treated material is passing through the aggregate. Material is crossflowing by gaseous medium. Processes are executed by their mutual interaction. By process execution inside the element material and heat balance is preserved. According the type of interactions flow can be divided on coflow (rotary furnace, high revolution rotary furnace) counter flow (shaft furnace, rotary furnace high revolution rotary furnace), cross flow (integrated thermal apparatus), and their combinations.

### Model of heating process

This model includes gas material heat transfer and heat conduction inside the material. The following basic equations have been used.

Heat transfer by convection:

$$Q = F \cdot \alpha \cdot \Delta t, \quad \alpha = f(\text{Re}, \text{Pr}, \lambda, d_h)$$

where F-heat exchange [m<sup>2</sup>];  $\alpha$ -heat transfer coefficient by convection [W.m<sup>-2</sup>.K<sup>-1</sup>],  $\Delta t$  - temperature difference between heat exchanging medium and sand the heating surface, Re-Reynolds criterion, Pr-Brandt criterion,  $\lambda$ -heat conductivity of gaseous medium [W.m<sup>-1</sup>.K<sup>-1</sup>],  $d_h$ - equivalent diameter of material particles [m].

Heat transfer by conduction

$$Q_k = F \lambda \frac{dt}{dx} \tau \quad [\text{J}]$$

Where  $\tau$  -time.

### Model of drying process

Includes evaporation and condensation model. Models are based on functional independence of partial pressure of saturated steam on temperature.

Condensed steam quantity is expressed by equation:

$$m_{\text{H}_2\text{O}} = V_{\text{med}} \rho \left( \frac{p_p}{p} - H_2\text{O} \right) \quad [\text{kg}]$$

Evaporated water quantity is:

$$m_{\text{H}_2\text{O}} = 0,622 \frac{\alpha \cdot S}{c_{p,\text{med}}} \left( \frac{p_p}{p - p_p} - \frac{\text{H}_2\text{O}}{1 - \text{H}_2\text{O}} \right) \quad [\text{kg}]$$

where  $V$  – gas volume,  $\rho$  – steam density,  $p_p$  –sated steam partial pressure,  $p$  – total pressure of gas mixture,  $\text{H}_2\text{O}$  – perceptual steam proportion in gas mixture,  $c_{\text{gas}}$  – specific heat capacity of gaseous medium,  $S$  – heat exchange area,  $d\tau$  - time step, 0,622 – proportion water steam density.

### Models of calcinations process

Includes decomposition of carbonates  $\text{FeCO}_3$ ,  $\text{CaCO}_3$  and  $\text{MgCO}_3$ .

#### a. $\text{FeCO}_3$ decomposition

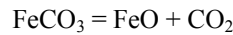

Dissociation is influence reaction between the products

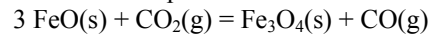

Therefore the whole process is best described by equation

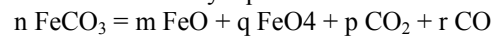

#### b. $\text{CaCO}_3$ decomposition according the equation $\text{CaCO}_3 = \text{CaO} + \text{CO}_2$

#### c. $\text{MgCO}_3$ decomposition according the equation $\text{MgCO}_3 = \text{MgO} + \text{CO}_2$

Quantity of the decomposed carbonate is:

$$m_{\text{rozklad}} = \beta \cdot S_{\text{mat}} \cdot \left( \frac{p_{\text{CO}_2}}{101325} - \frac{V_{\text{CO}_2}}{V_{\text{celk}}} \right)$$

Where  $\beta$ -velocity constant [ $\text{kg} \cdot \text{m}^{-2} \cdot \text{s}^{-1}$ ],

$S_{\text{mat}}$ -surface [ $\text{m}^2$ ],

$p_{\text{CO}_2}$ -sated steam partial pressure [Pa],

$V_{\text{CO}_2}$ -volume of  $\text{CO}_2$  in flue gases [ $\text{m}^3$ ],

$V_{\text{celk}}$ - flue gases volume [ $\text{m}^3$ ].

Model parameters for calcinations kinetics were determined according laboratory experiments (Fig. 5).

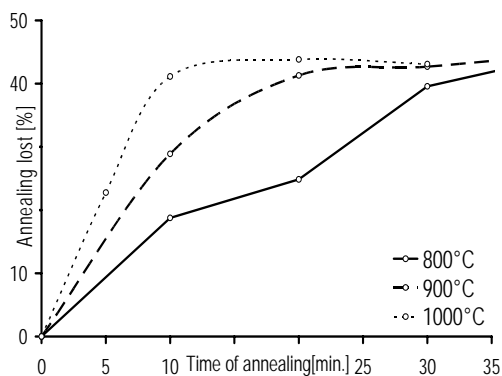

Fig. 5. Magnesia calcination experiment.

### Application to integrated thermal apparatus

Developed mathematical model represents internal process structure and has structural adequacy to the real process. Model generation relies on synthesis of elementary models, which includes:

- models of transfer,
- models of accumulation,
- models of transformation.

Their synthesis is according the balance equations.

Mathematical model of the integrated thermal apparatus is complex. It consists of simulation model, database and visualisation interface.

Simulation model represent solution of equations describing the process according the appropriate solution method. For the solution elementary balance method was used. This method well satisfies specified requirements. Its further advantage is the simplicity. By basic models complex simulation models are generated. Interconnection of discrete simulation models is realized by specific modules generated for a given situation. By this way for specific situation models of different complexity can be generated.

Simulations can be executed on the different hierarchical levels. Transition to lower levels means increasing of discrimination ability. Discrimination levels include process foundations.

Model representing the aggregate is decomposed in to zones (Fig. 6) which have equal parameters, for example, equal fuel input, or layer thickness. Each zone is decomposed on layers, the layer consists from elements. Material and thermal balance is executed for each element.

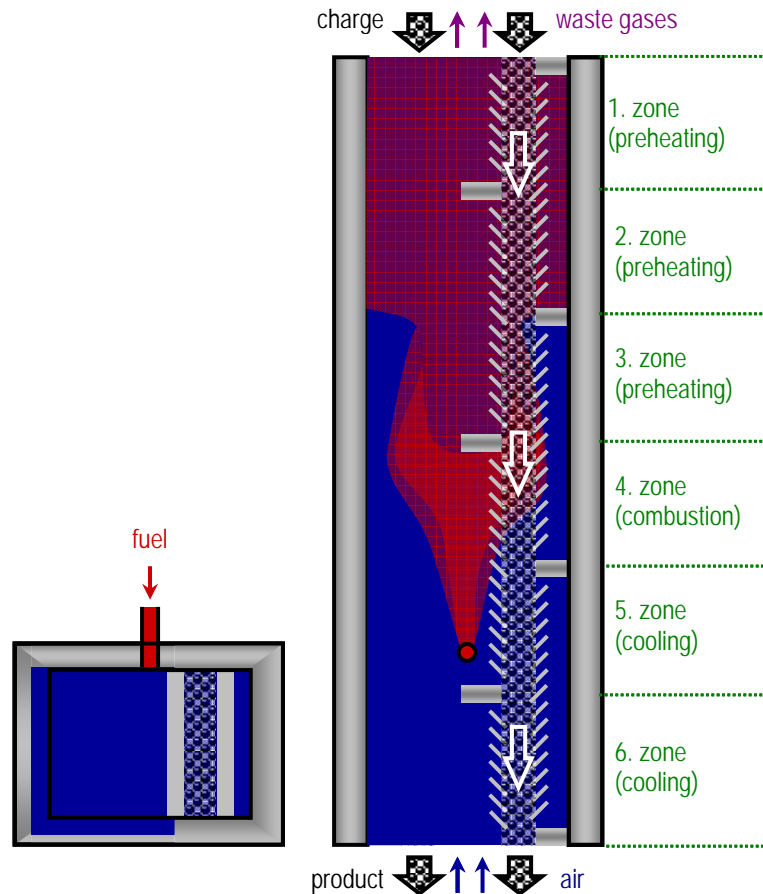

Fig. 6. Material and gaseous media interaction in the zone element.

### Process visualisation

Outputs from mathematical simulation model, which creates basis for visualisation, are in the scalar data form. Therefore for visualisation of running processes multidimensional graph method was selected. Created visualisation system transforms data from the mathematical model into the form, in which visualisation in virtual reality is possible (Fig. 7) (POLČOVÁ, K., MIKULA, J., KOŠTIAL, 2009).



Fig. 7. Structure of the visualization system.

Selection of the programming language for data arrangement and for graphical outputs generation, significantly depend on the original mathematical model. The free Pascal programming language was used in Lazarus graphical surrounding. By its intermediation created application enables import of textual sets including X-Y-Z data, which we wish to visualise (Fig. 8).

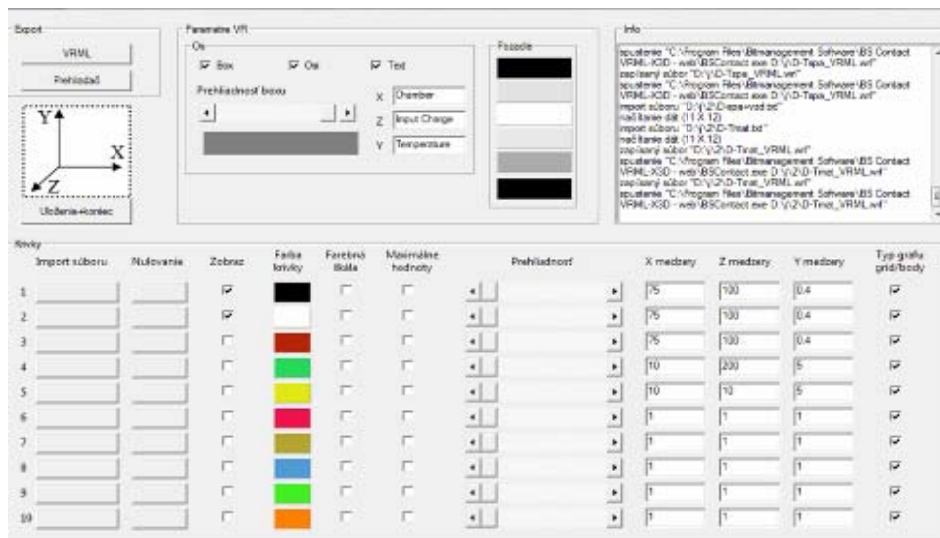

Fig. 8. Application of 3D data conversion into VR.

The output is planar graph in the VRML form (Fig. 9, Fig. 10). The graph includes axis with their description, scale X-Y-Z, transparency and highlighting of maximal values.

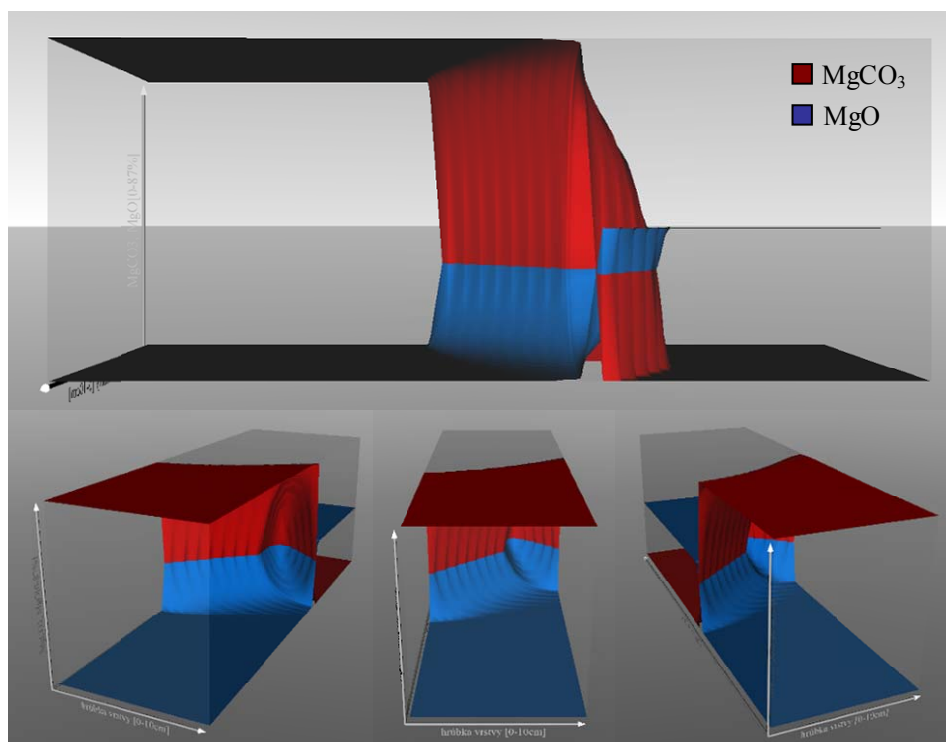

Fig. 9. Calcinations  $MgCO_3$  in integrated thermal apparatus.

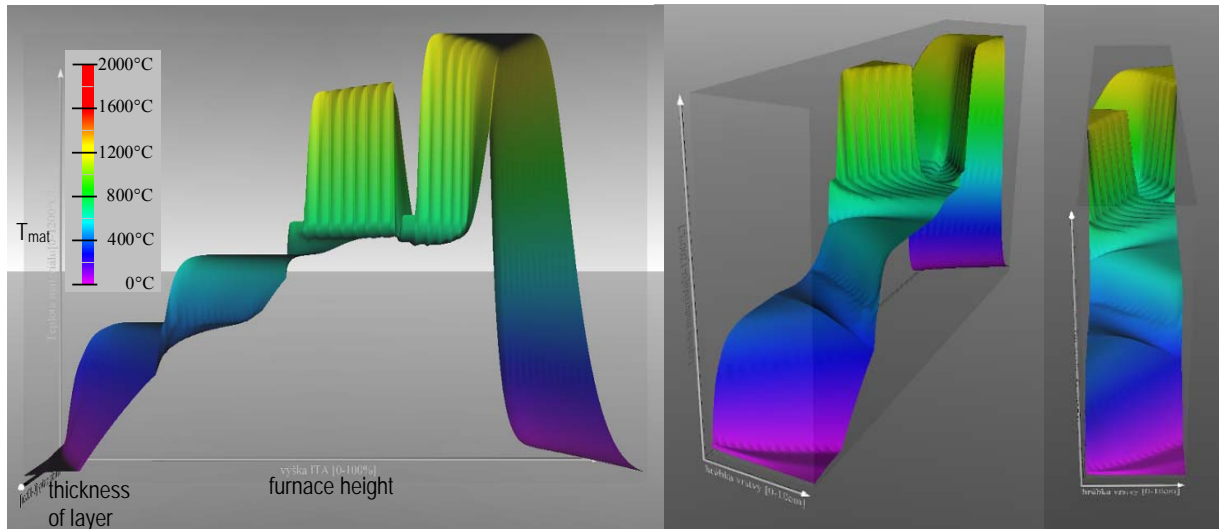

Fig. 10. Temperature distribution in the integrated thermal apparatus.

Generated graph can be examined by the standard browsers of internet www pages with additionally installed VRML plugin. Dependently on presented information, VRML language offers more interpretation alternatives. Created environment gives the presentation possibility not only of one process but enables to gain information from others. Such presentation has for the user high expressing value because it enables visual comparison. For example it is very important for the quality control.

### Conclusion

Developed mathematical model can be used for simulation of granular materials thermal treatment. They have been effectively used for variety of materials and energy processes [6, 7]. Modular structure of the model enables its effective utilisation for design and control purposes. Application of first principles enables its utilisation in the extrapolation area. Model adequacy is secured by experimental determination of its parameters and on its calibration on experimental furnace

Virtual reality enables effectively represent information about objects and processes executed in them. Its use is mainly for knowledgeability increasing about given process. Visualisation system can fulfil important task by support of operational activities as monitoring, diagnosis and solution of break down situations. Visualisation system has to give support to the operator and engineer by diagnosis of complicated situations, predictions, and by selection of control actions. Important function is real time analysis, which enables to the user dynamic way of thinking and creating intuitive feeling about system work. At control system creation the key problem is its safety. Checking of basic functions on real objects is from many reason requiring. One of the alternatives is using of simulations on mathematical models, on which we can change not only operation but also design parameters. Advantage of such approach in research and development is the possibility of immediate correction of control algorithm, influence evaluation of different failures and break down situations, generation and testing of different working regimes. Simulations of working conditions of technological process enables to analyse properties of the process and aggregate from view point of technological quantities which are not measured continually or are not measured at all. Analysis results gained from the research serve to deeper understanding of the process and its inputs. Important contribution is mainly in risk minimisation and in decreasing number of experiments on the real plant.

**Acknowledgement:** This contribution/publication is the result of the project implementation "Research excellence centre on earth sources, extraction and treatment" supported by the Research & Development Operational Programme funded by the ERDF.

### References

- [1.] Kostial I., Spisak J., Mikula J., Glocek J., Nemcovsky P. and Terpak J. Advanced process manipulation of magnesia sintering, In: Proceedings of the 17th World Congress. *The International Federation of Automatic Control, Seoul, Korea, July 6-11, 2008, pp.718-723.*
- [2.] Mikula J. et al. : Mathematical modelling of lumpy and granular material thermal treatment. In: *Acta Metallurgica Slovaca, ISSN 1335-1532, vol. 15, no. 1 (2009), pp. 197-204.*
- [3.] Mikula J. et al. : Generation of mathematical hierarchical models for virtual reality environment. In: ICC'C'2009. Zakopane, Poland, May 24-27, 2009, Krakow : AGH - University of science and Technology, 2009. ISBN 8389772-51-5, pp. 419-422.
- [4.] Dorčák, D., Spišák, J.: Využitie reinžinieringovej metodológie pri komplexnej optimalizácii procesov získavania a spracovania surovín, *Acta Montanistica Slovaca, 2004, ISSN 1335-1788.*
- [5.] Petráš, I., Bednárová, D.: Total Least Squares Approach to Modeling: A Matlab Toolbox, *Acta Montanistica Slovaca, 2010, pp. 158-170, ISSN 1335-1788.*
- [6.] Kostúr, K., Sasvári, T.: Research of lignite underground gasification, *Acta Montanistica Slovaca, 2010, pp. 121-133, ISSN 1335-1788.*
- [7.] Kostúr, K., Kačur, J.: The monitoring and control of underground coal gasification in laboratory conditions, *Acta Montanistica Slovaca, 2008, pp. 111-117, ISSN 1335-1788.*
- [8.] Petre, E., Popescu, D., Selisteanu, D.: Adaptive control strategies for a class of nonlinear propagation bioprocesses, *Acta Montanistica Slovaca, 2008, pp. 118-126, ISSN 1335-1788.*
- [9.] Olijár, A., Lišuch, J., Dorčák, D., Spišák, J.: The Proposal for optimization the kinetics of the process the caustification of magnesite, *Acta Montanistica Slovaca, 2011.*