

## Principles of computer simulation design for the needs of improvement of the raw materials combined transport system

*Martin Straka<sup>1</sup>, Andrea Rosová<sup>1</sup>, Radim Lenort<sup>2</sup>, Petr Besta<sup>3</sup> and Janka Šaderová<sup>1</sup>*

*This article is focused on computer simulation design for raw materials transportation. The creation of a simulation model of the combined transport system for the raw materials transportation has its own problematic parts. In general, these are parts, which represent transport nodes, i.e. parts of the system in which raw materials are reloaded from one vehicle to another. The given operations are in practice dependent on the preparedness of all transportation means, which participate in it. To locate operations of reloading of the raw materials from one vehicle to another and the check of the preparedness of the vehicles of the reloading in the simulation system is more demanding because it is necessary to take into consideration several aspects, such as an existence of a vehicle with raw materials, an existence of a vehicle to which it is to be reloaded, a suitable freeloader, and so on. The article focuses on defining a procedure and correct steps at the creation of the simulation computer model of the combined raw materials transport system in the EXTENDSIM simulation system based on specific data from a real transport system. As is clear from the proposed procedure of the creation of the combined raw material transport system, as a check element of the transport system preparedness, it is suitable to use the "Gate" block and its features in the EXTENDSIM simulation system. As transpires from the results of simulation of the combined raw material transport system, about 322,000 tons of raw materials at 90-96% with the use of all vehicles is transported during the year.*

**Key words:** computer simulation, EXTENDSIM, combined transport system, raw materials, improvement.

### Introduction

Successful realisation of transportation of millions of tons of raw materials with the use of different types of transportation depends on many factors. It is important to effectively set the logistic activities, such as loading, material transfer and unloading, effectively use technical resources and minimisation of delay and reconstruction times. It is not easy to design such a system due to time and distance reasons. That is why a suitable instrument for effective setting and testing such systems focusing on raw material transportation appears to be the use of computer simulation. The quality of the output and data depends on the quality of the realised analysis and a correct procedure, verification, validation and realisation of the simulation model. What procedure is better for designing such a system is not clear. That is why the article focuses on defining a procedure and correct steps at the creation of the simulation computer model of the combined raw materials transport system. An instrumentality of the computer simulation will be the EXTENDSIM system. The consequence of the steps is however usable for whatever simulation system and project of freight transport.

Activities closely tied to material flow can proceed simultaneously with the material flow, they can follow the material flow, or even against the material flow (Straka, 2010; Drastich, 2017). The problematics of identification of the common signs during designing combine transport systems with the help of particular simulation systems is in general significant and important, what is proved - among others - by general interest to the solved problematics of many other authors and designers. Some general principles are necessary to consider in the design and analysis of the material flow, for example a classification of the states, a system, cell or workstation and tips on how to define other possible alternative material flow scenarios (Delgado Sobrino et al., 2013; Pacana et al., 2014; Malindzakova et al., 2015). From the point of view of the mining activity and consequential treatment of raw materials, it is necessary to evaluate such activity very sensitively and thoroughly and emphasise the living environment. According to the authors Burchart-Korol et al. (2016), Witkowski and Kiba-Janiak (2012) and Khouri et al. (2017), life cycle assessment is important for the environmental evaluation of mining operations, which enables assessment of the factors that are both directly and indirectly affecting the environment and are associated with the production of raw materials and energy used in processes. It is clear from the above mentioned that solving a combine raw material transport system with the help of simulation systems has such higher importance because it enables us to set and propose a system in such activity to remove many important inadequacies (Grujic et al., 2011).

<sup>1</sup> Martin Straka, Andrea Rosová, Janka Šaderová, Institute of Logistics, BERG Faculty, Technical University of Kosice, Park Komenského 14, 04384 Kosice, Slovakia, [martin.straka@tuke.sk](mailto:martin.straka@tuke.sk), [andrea.rosova@tuke.sk](mailto:andrea.rosova@tuke.sk), [janka.saderova@tuke.sk](mailto:janka.saderova@tuke.sk)

<sup>2</sup> Radim Lenort, Department of Logistics, Quality and Automotive Technology, ŠKODA AUTO University, Na Karmeli 1457, 293 01 Mlada Boleslav, Czech Republic, [radim.lenort@savs.cz](mailto:radim.lenort@savs.cz)

<sup>3</sup> Petr Besta, Department of Economics and Management in Metallurgy, Faculty of Metallurgy and Materials Engineering, VŠB - Technical University of Ostrava, 17. listopadu 15, Ostrava-Poruba, 708 33 Ostrava-Poruba, Czech Republic, [petr.best@vsb.cz](mailto:petr.best@vsb.cz)

According to the authors Straka et al. (2017), in the same way as the company gradually goes through different stages of development, so can the means of simulation modelling adapt to the requirements of any given development stage. Similarly, as a house is gradually being constructed so the simulation models can be built from specific blocks, objects, components and other tools within the simulation systems. The current possibilities of the computer simulation approach enable us to mimic the real processes of logistic production activities as well as of the actual production and transportation.

### Literature review

The use of computer simulation for solving systems that are complicated, dangerous, tricky, in a phase of the prototype, unavailable, expensive and so on, became inevitable. From the point of view of the administration of the transport systems in time, it is mainly dynamical systems and dynamical simulation. According to the authors Zemanová, Botek and Strachotová (2017), Straka (2017) dynamic simulation is a powerful tool for optimising processes within the company. The meaning of computer simulation and the correct setting of the entire combine transport system is also important from the point of view of the effective management of the transfer of millions of tons of raw materials. Effective management of the provision of raw materials at the raw materials reloading point shall save costs of the transport itself and does not saturate a general transport network (Besta et al., 2016; Folega and Burchart-Korol, 2017). The computer simulation is one of the stable instruments for the implementation of internal and operational costs. Contemporary enterprises are constantly looking for new methods and solutions (including simulation) that allow their competitiveness to be increased and help them to improve the quality of decision-making and reduce the time and cost of the processes (Saniuk et al., 2014). Computer simulation and simulation software can be used in many branches. According to the authors Botek (2005), Dupláková, Knapčíková et al. (2017) and Straka et al. (2018), it is possible to use simulation software in the manufacturing plants. They are using the simulation software for cutting, milling, drilling, planning, assembly, manufacturing, management. It is possible to use the simulation software during the production of composite materials in the simulation of material flows.

According to the authors Taušová et al. (2017) and Wittenberger et al. (2012), the mining industry is in constant development on every continent. The reason is increasing demand for raw materials. The acquisition of mineral raw materials is the most important part of the mining industry, which produces raw materials worth hundreds of millions of euros per year in Slovakia alone. It is related to and increases the importance of the transport of raw materials.

European transport policy has undergone significant transformations both taking into account its range as well as implementation instruments since 1957. Contemporary conditions of the social and economic situation determine the existence of wide interactions between objectives of the strategy Transport 2050 and other European Union policies, like environmental and cohesion policy or support of research and innovations. In this situation, the efficient coordination of both programming (simulation too), as well as implementation instruments of these policies, has become a fundamental challenge (Straka and Malindzak, 2009; Drejerska, 2011; Kiba-Janiak, 2017). The Central and Eastern European region has grown dynamically over the past decade, starting its development even before the accession of many of the leading economies to the European Union. Infrastructure shapes mobility. No major change in transport will be possible without the support of an adequate network and more intelligence in using it (Hricová, 2017).

According to the authors Straka et al. (2016), logistics as a cross-sectional area in companies, including those with chemical production, aims to combine the material, spatial and temporal differentiation of the production and consumption in the liaison positions between the single economic subjects logically and cost-effectively. However, it is important to realise that a pragmatic delimitation of logistics characterises its mission narrowed to the sub-areas of the logistics system primarily for supply, storage or transport.

### Analysis of the evaluated combined transport system

To enable the composition of a complex simulation model of the raw materials transport system activity, it is necessary to prepare and realise a thorough analysis of the transport system elements. The activity of the objective transport system can be classified as a flexible connection between the source of the raw materials and the point of their industrial using. The whole raw materials transport system consists of several parts. The first part of the system is created by the railway freight transport. The second part of the system is a loader, which withdraws raw materials from the freight wagons and reloads them to the trucks. The next part of the transport system is created by the instruments of the freight transport that carry out the loaded raw materials to the place of their processing. The last part of the freight system is created by the road infrastructure.

The input flow is created by thousands of tons of the delivered raw materials by means of the railway transport resources. The raw materials are loaded from the wagons with the help of a loader to the arrived trucks, which carry out them to the raw materials dumping place that serves for the industrial usage.

The following findings result from the system analysis of the transport system activity:

- Annually, about 322,000 tons of raw materials are transported by the railway.
- Transported raw materials come through several levels of transportation. The first level of transportation is created by the transport of raw materials from the place of mining by means of railway freight transport. Transfer of raw materials with the help of instruments for loading and unloading creates the second level of transportation. The third level of transportation is created by the road freight transport to the place of destination and processing the raw materials.

From the point of view of the general activity of the raw materials transport system, it is necessary to remember some following findings and parameters:

- One train consists of tens of freight wagons.
- The second level of transportation of the raw materials consists of one loader with a shovel capacity of 0.86 ton.
- The third level of transportation is created by three trucks. One truck has a capacity of 7.8 tons.
- The loader needs 4 minutes for the loading of one truck.
- The truck will overcome the road to the dumping place of raw materials by 1.75 minutes.
- One full wagon contains 70 tons of raw materials, what represents loading about of 9 pcs of trucks.
- Provided all vehicles be loaded, the train and the loader have to wait for returning back empty vehicles.
- When the train is unloaded, the vehicles and the loader have to wait for the addition of the following train loaded by raw materials.
- An addition of one wagon takes approximately of 1.5 minutes.

### The composition of a formalised and block scheme for raw materials transport

Raw materials transportation and the activity of the entire transport system has its parameters, limitations and a precise sequence. Based on the information mentioned above and the analysis of the transport system activity, it is possible to compose its formalised scheme (Fig. 1). The formalised scheme represents the whole transport system with its elements and interconnections. Elements of the system create separate parts and levels of transportation and transport operations with raw materials.

The composed formalised scheme creates a very important base for the creation of the simulation system itself. Particular parts of the formalised scheme are consequently replaced by appropriate blocks of a specific simulation system. The creation of the simulation model consists of two parts. The first part is represented by a block scheme of a corresponding simulation system (Fig. 2) and the second part is the simulation model itself with the realisation of the research for the sphere of transportation of raw materials and the logistics (Fig. 3).

The composition of the block scheme as source materials for the simulation model itself is important for the preparation of data and information that are necessary for the setting of separate blocks of the simulation model.

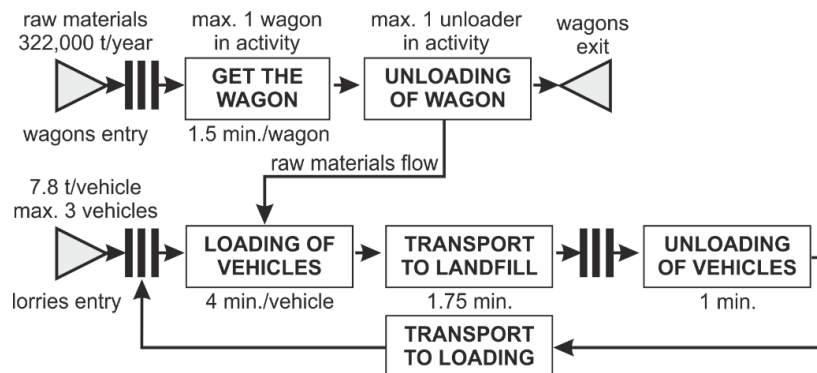

Fig. 1. Formalised scheme of the combined transport system of the raw materials traffic.

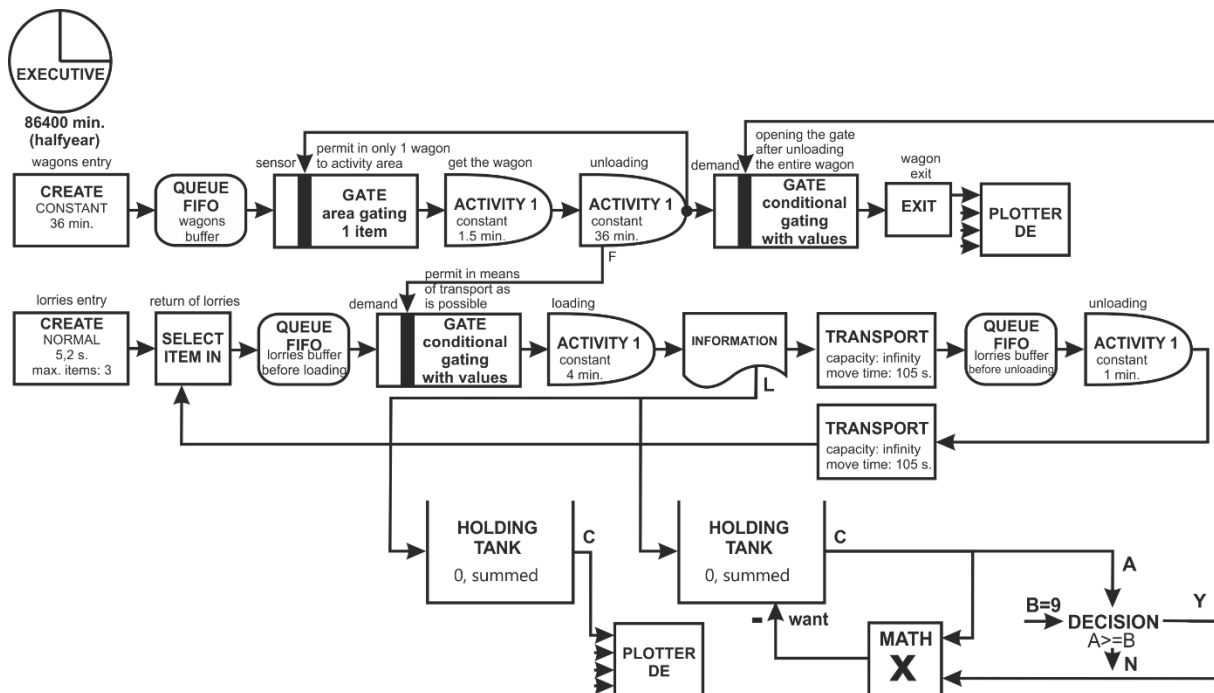

Fig. 2. Block scheme of the combined transport system of the raw materials traffic.

### Proposal for a simulation model of the combined raw materials transport system

It is clear from the statistical data obtained from the operation of the raw materials transport system that the transfer of raw materials to a railway-reloading centre is approximate of 322,000 tons of raw materials annually. As is clear from the detailed data analysis, about 0.613 tons of raw materials is delivered by the railway every minute.

From the point of view of the creation of the simulation model itself and covering the activity of the entire transport system, two parts are very important:

1. The train with raw materials is added and is not empty, but all trucks are loaded, i.e. they realise transportation to the dumping place of raw materials or are on the way.
2. The trucks are prepared for loading, but the train is after unloading, and it is necessary to wait up for the addition of the next train full with raw materials.

In both cases, a lost time has to occur in part of the transport system, which is just physically unavailable.

Another interesting thing from the point of view of the creation of the simulation model of the evaluated transport system is that a dynamical element under the general name of "request" represents coming transport means. From the first entry, these are generated wagons, and from the second entry, these are generated cargo vehicles.

The given state from the point of view of the creation of the simulation model of the whole transport system, it is necessary to imitate in a concrete simulation system so that it corresponds to the activity the evaluated real system, what is not easy in many simulation systems.

Parts of the simulation model are characterised by the availability of blocks that are connected with junctions, which uniquely determine the direction of the flows. Their position, icon and a block name, blocks connectors, junctions, dialogue boxes with operands and flows define basic characteristics of particular blocks of the model. Each used block occupies a certain place, a position in the simulation model, which represent a real evaluated system. The blocks themselves represent certain parts of the processes or operations from which the model of the evaluated real system itself is created. Icons and names of the blocks are illustrative images of the blocks with their precise unique name that describe their basic function. Each block has its unique icon and its unique name that expresses its basic usage within the models. The block named „Create“ represents generating entries of requests (waste in tons) to the model; the block named „Queue“ characterises the creation of series of requests, with an entry into the series, including its leaving. The block named „Exit“ represents an output from the model according to the requests that will input into the block.

Connectors of the blocks are parts of the icons that enable connection of the blocks between each other, whereas a rule has to be observed that it is necessary to connect only input connectors with output connectors. By connecting the connectors of two different blocks, a logical sequence of blocks corresponding to a real system and the base of origination of the flow of requests and values is created. The connection of the blocks between each other will provide the creation of flows and invoke their control and check. The connection of the blocks has to represent a real sequence of the blocks as well as in the examined system. By connection of two blocks via their connectors, a junction will be created (a doubled or simple line), which unequivocally encloses a sequence of the blocks and a direction of the flow of the requests and values. Dialogue boxes and operands represent specific items, features of the blocks, which are characteristic for separate blocks and necessary for the activity of separate blocks. In case of the opening the dialogue box of the block, specific parameters and features of the block will be displayed, which can be or have to be set for the concrete block.

As far as dynamic elements in the simulation model are represented by the requirements of „Wagon“ and „Truck“ type, etc., generators of inputs will be adapted to the given conditions.

Parameters of the generation of the entry of wagons into the modelled transport system of the first entry generator named „Create1-Wagons entry“ are set to the distribution function with a division of „Constant“ of 36 min. The given setting will ensure the insertion of one wagon full of raw materials into the examined transport system.

Parameters of the generation of the entry of trucks into the modelled transport system of the second generator of entry named „Create2-Vehicles entry“ are set to the distribution function with a division of „Normal“  $5 \pm 2$  seconds; the maximum number of the generated requests is adjustable to the value of 3. The given setting will ensure insertion of at the most of 3 trucks into the examined transport system in the given time division. As far as the raw materials dumping place is close to the loading point for the trucks within the whole system, three trucks are enough.

From the point of view of modelling a procedure of the entire train via the raw materials reloading centre, the connection of „Queue1-Gate1-Activity1-Activity2-Gate2-Exit“ blocks will follow up.

The „Queue1“ block represents an accumulator, i.e. auxiliary track, to which it is possible to place eventual next incoming wagons with raw materials.

The „Gate1“ block provides a check or an incoming wagon that has been already fully unloaded. If the incoming wagon has not yet been unloaded, then the „Gate1“ block will not let go the next wagon for unloading. Provided the incoming wagon has been already fully unloaded, the „Gate1“ block will let go the next wagon for unloading.

The consequence „Activity1“ block represents an addition of the wagon to the place of unloading, what standardly lasts 1.5 minutes. That is why the block is set to a delay with the „Constants“ segmentation of 1.5 minutes. At the same time, no other wagon can be unloaded.

The next „Activity2“ block represents unloading of raw materials from separate wagons. Unloading of a whole wagon takes approximately 36 minutes. That is why the block is set to a delay with the „Constants“ segmentation of 36 minutes.

The „Gate2“ block provides a check whether the wagon is already fully unloaded in the raw materials unloading position. If the wagon is not yet fully unloaded, then the „Gate2“ block of the wagon will not let it go the stands and unloading of raw materials. Provided the wagon is fully unloaded, the „Gate2“ block will let the wagon leave the transport system via the „Exit“ block. The „Gate2“ block is informed of the full unloading of the wagon via the „Decision“ block provided the condition be met that the given wagon maintained at least 9 pcs of trucks, what represents a discharge of one full wagon.

The „Exit“ block enables the unloaded wagons to leave the whole examined transport system.

From the point of view of modelling the activity of the road cargo transportation depending on the need of loading, driving-away and unloading of raw materials on a closely situated raw materials dumping place, a connection of „Select Item In-Queue2-Gate3-Activity3-Information-Transport1-Queue3-Activity4-Transport2“ blocks gets on.

The „Select Item In“ block serves for the security of the position of the incoming trucks into a queue in front of the loader of raw materials.

The „Queue2“ block represents a queue of the unattended non-loaded trucks, which wait in a queue for loading.

The „Gate3“ block provides a check whether there is available a wagon with accessible raw materials. If present, a wagon is not added, and trucks are prepared for loading, then the „Gate3“ block will not let the next truck go to the attendance, for the loading with raw materials. If a wagon with raw materials is available, then the „Gate3“ block will allow in the next truck for the loading with raw materials.

The „Activity3“ block represents loading of the vehicles with raw materials from separate wagons. The loading of one truck lasts approximately 4 minutes. That is why the block is set to a delay with the „Constants“ segmentation of 4 minutes.

The „Information“ block serves for the sending information about the serviced trucks via the connector „L“ to the „Holding Tank“ block, which consequently summarises the number of the serviced trucks, for the needs of assessment of the condition for the check of wagon unloading.

The „Transport1“ block represents a way as a multi-channel servicing equipment. It is the way, which has to be overcome from the station of loading to the enterprise mine of raw materials. Any number of trucks may be in the way at the same time. There are three trucks in our system. The truck will overcome the way by 105 seconds. Therefore the block in the „Travel time“ item is set to „Move time“ of 105 seconds.

The „Queue3“ block represents a queue of the unattended non-unloaded trucks, which wait in a queue for unloading in front of the enterprise mine of raw materials.

The „Activity4“ block represents unloading, emptying the trucks in the enterprise mine of raw materials. The unloading, emptying one truck lasts approximately 1 minute. That is why the block is set to a delay with the „Constants“ segmentation of 1 minute.

The „Transport2“ block represents a way as a multi-channel servicing equipment. It is the way, which has to be overcome from the enterprise mine of raw materials to the station of loading for trucks, i.e. the way back to the station. Any number of trucks may be in the way at the same time. The truck will overcome the way by the same time of 105 seconds. Therefore the block in the „Travel time“ item is set to „Move time“ of 105 seconds. The closure of the cycle of the trucks is being realised by the entry connector of the „Select Item In“ block.

The prepared block scheme of the model of activity of the combined transport system represents an inactive part of the computer simulation model itself. An application of the block scheme in a particular simulation model comes on, thanks to which the inactive part will become an active computer simulation system. The result of the active part of the realisation of the simulation model is data representing the present state of activity of the combined transport system. By modification of parameters and examination of other effects to the created simulation model, it is possible to define recommendations and improvements of the activity of the combined raw materials transport system.

The simulation model of the combined transport system consists of blocks (Fig. 3) representing separate parts, operations within the transport system (addition, withdrawal, unloading, loading, transportation). Each block of the simulation model has its own meaning and substantiation. Not all operations can be modelled with one corresponding block, but several blocks have to be used in a sequence, which corresponds with a real activity of the combined transport system. No less important part of the entire simulation model is the thorough setting of parameters of the simulation model as it results from the analysis, the formalised and block scheme.

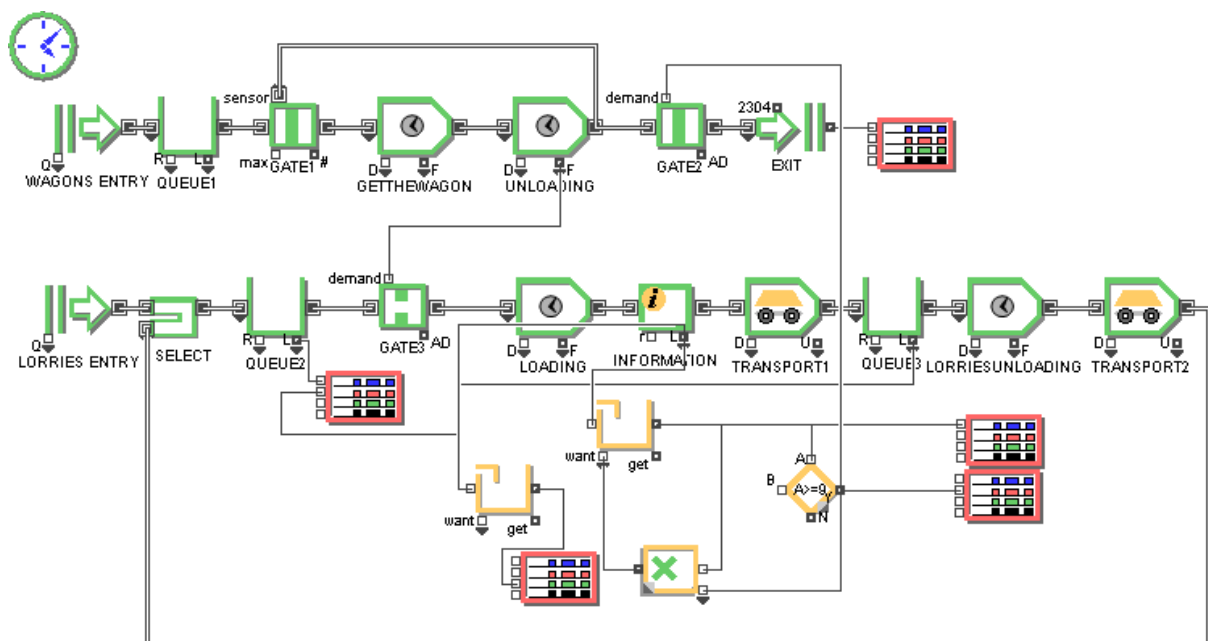

Fig. 3. The simulation model of the combined transport system of the raw materials traffic.

### Settings of the simulation model of the combined raw materials transport system

To put blocks on the modelling area of a particular simulation system is no problem. The problem is to give a logical sequence for the connection of the blocks and set the parameters of the blocks so that they correspond to the real factual system.

The „Create1 Wagons Entry-Queue1-Gate1“ blocks (Fig. 4), represent driving-in the wagons with the loaded raw materials. In case of occupation of the railway, a position on which another wagon with raw materials is just being unloaded, the next incoming wagon will remain in a queue of waiting for non-unloaded wagons, full of raw materials.

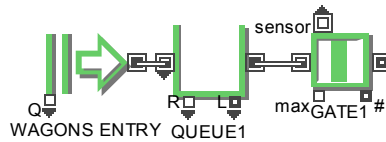

Fig. 4. Blocks „Create1 Wagons Entry-Queue1-Gate1“.

For the provision of the entry of the incoming loaded wagons to the reloading place of raw materials, it is necessary to set a distributing function according to the parameters recorded in the block scheme of the model (Fig. 5).

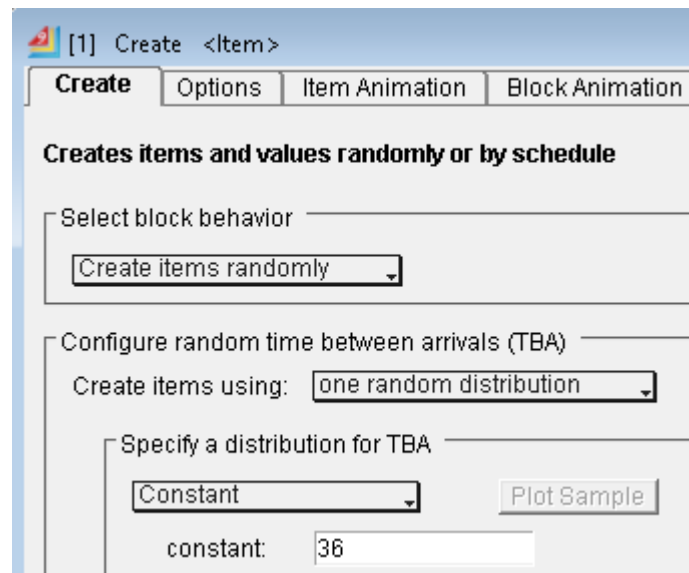

Fig. 5. Dialogue of the block „Create1-Wagons Entry“ and its setting according to the requirements of the simulation model.

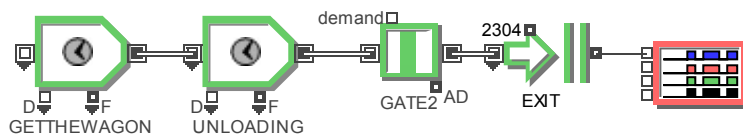

Fig. 6. Blocks „Activity1 GetTheWagon-Activity2 Unloading-Gate2-Exit“ and „Plotter“.

The „Activity1 GetTheWagon-Activity2 Unloading-Gate2-Exit“ blocks (Fig. 6) and „Plotter“ which represents an addition of the wagons, their unloading, leaving the system and simulation data recording. The „Activity2-Unloading“ block represents unloading of the incoming loaded wagons. In the block, it is necessary to set parameters of the duration of wagons unloading (Fig. 7) according to the analysis and according to the data in the block scheme.

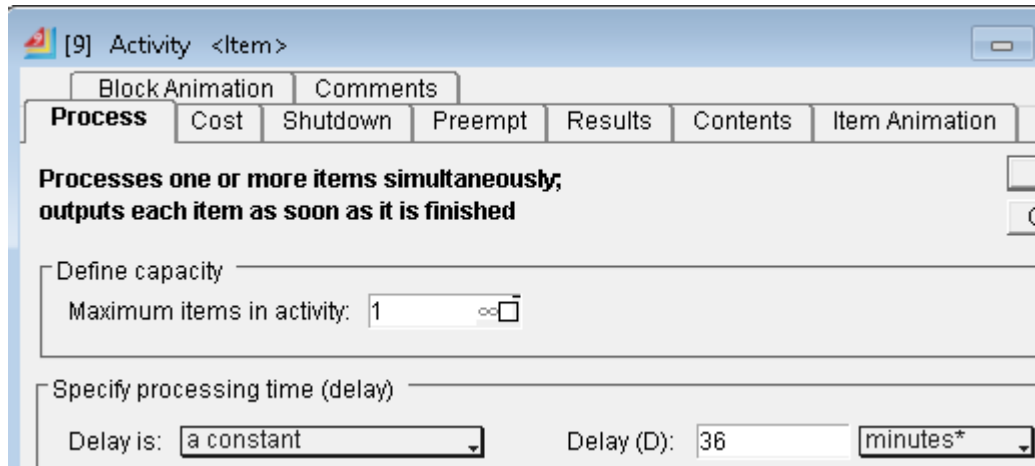

Fig. 7. Dialogue of the block „Activity2-Unloading“, which represents the duration of the unloading of the wagons.

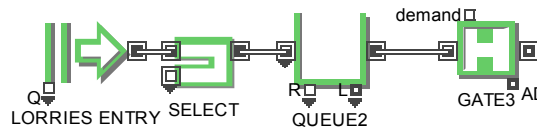

Fig. 8. Blocks „Create2 Trucks Entry-Select Item In-Queue2-Gate3“.

The „Create2 Trucks Entry-Select Item In-Queue2-Gate3“ blocks (Fig. 8) represent driving-in the trucks into the combined transport system. In case of occupation of the position of loading of the trucks by another truck, the next incoming truck will remain in a queue of the waiting non-loaded trucks.

For the provision of the entry of the incoming empty trucks to the reloading place of raw materials, it is necessary to set a distributing function according to the parameters recorded in the block scheme of the model (Fig. 9).

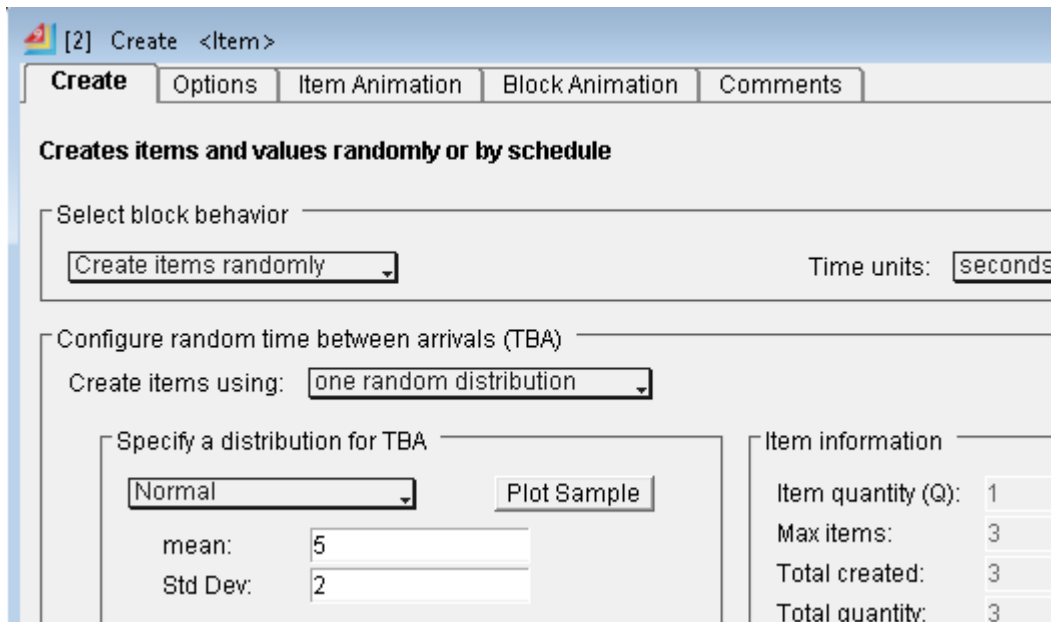

Fig. 9. Dialogue of the block „Create2-Trucks Entry“ and its setting according to the requirements of the simulation model.



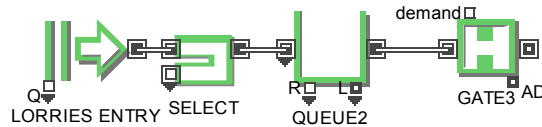

Fig. 10. Blocks „Activity3 Loading-Information“.

The „Activity3 Loading-Information“ blocks (Fig. 10) which represent driving-in the trucks, their loading and sending information about a number of the loaded trucks to the next parts of the system depending on the needs of the control of the course of the simulation model. In the block, it is necessary to set parameters of the duration of trucks loading (Fig. 11) according to the analysis and according to the data in the block scheme.

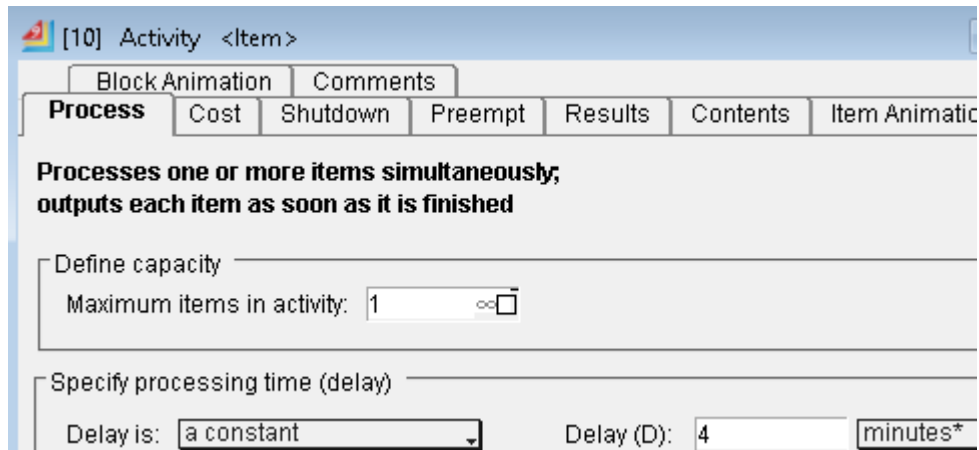

Fig. 11. Dialogue of the block „Activity3-Loading“, which represents the duration of the loading of the trucks.

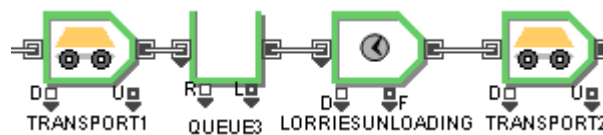

Fig. 12. Blocks „Activity3 Loading-Information“.

The „Transport1-Queue3-Activity4TrucksUnloading-Transport2“ blocks (Fig. 12) which represent a transfer of the loaded trucks to the place of unloading, sequencing the trucks into a queue of the waiting non-unloaded trucks, the realisation of unloading of the trucks and their return to the place of loading with the next raw materials. In the block, it is necessary to set parameters of the duration of the transfer of the loaded and the return of emptied trucks („Transport1“ and „Transport2“) (Fig. 13) as well as the duration of unloading of raw materials in the mines of the company („Activity4TrucksUnloading“) (Fig. 14) according to the analysis and depending on the data in the block scheme.

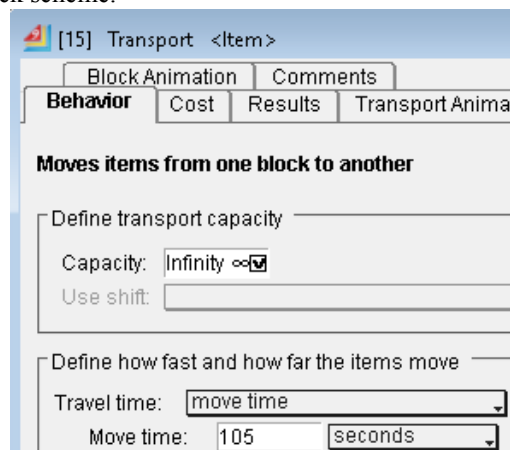

Fig. 13. Dialogue of the blocks „Transport1“ and „Transport2“, which represent overcoming the distance.

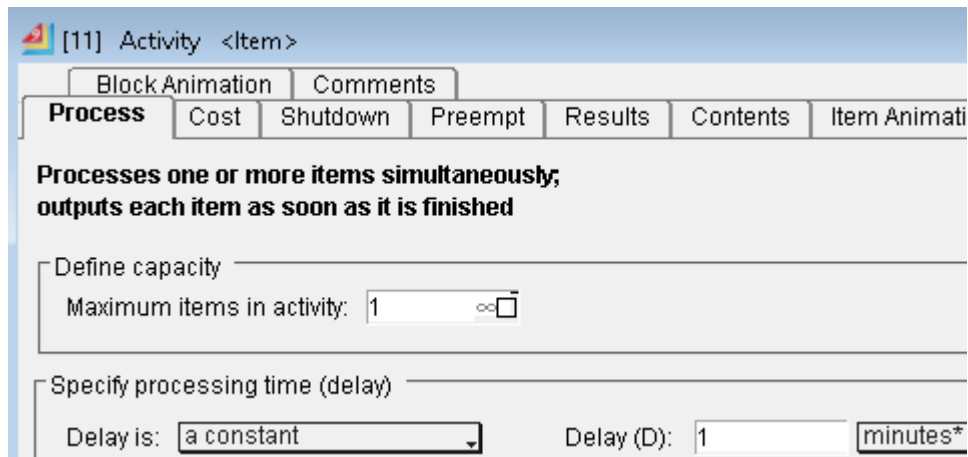

Fig. 14. Dialogue of the block „Activity4-Unloading“, which represents the duration of the unloading of the trucks.

### Results and conclusion

After setting the simulation model, its usage goes on for the aim of examination of the activity of the combined raw materials transport system. The benefit of the computer simulation is also that it is possible to examine states, which could not be possible in reality or would not be possible from the point of view of the safety of the examined system. The simulation simulates the activity of the system during half of the year and its workdays, i.e. 86,400 minutes. The entry of one element into the system represents driving-in 70 tons of raw materials.

As it is clear from the results of the simulation, the combined transport system during half of the year will convey approximately 2304 of loaded wagons, what represents 322.560 tons of raw materials for the whole work year (Fig.15).

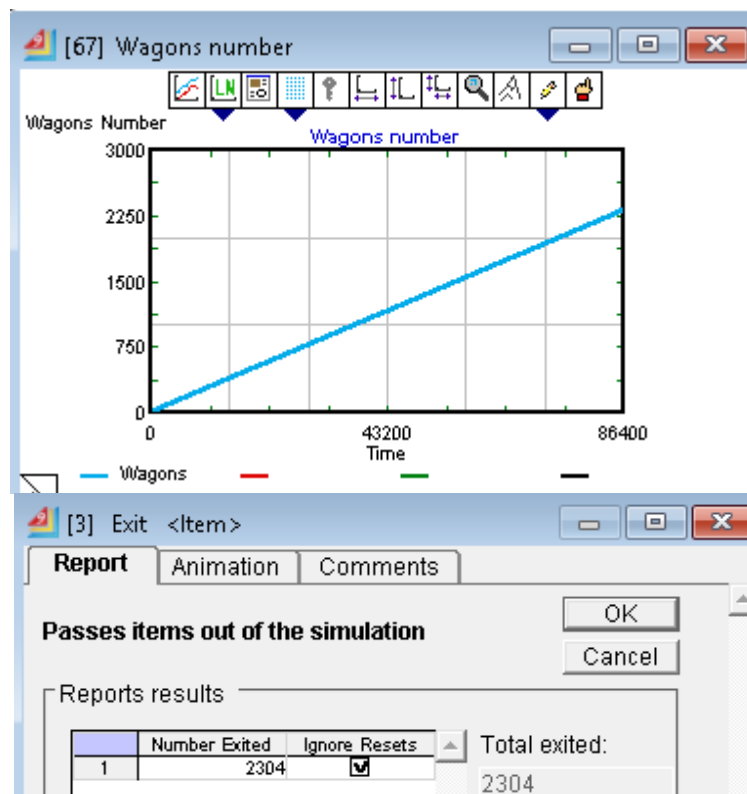

Fig. 15. The number of serviced, emptied wagons for the half a year.

Based on the examination of different settings of the combined transport system (Fig. 16), it is possible to say that three trucks with a capacity of 7.8 tons are enough for the entire provision of the activity of the combined transport system. While provisioning parallel unloading of several wagons at the same time, it is possible to increase the performance of the entire combined raw materials transport system several folds.

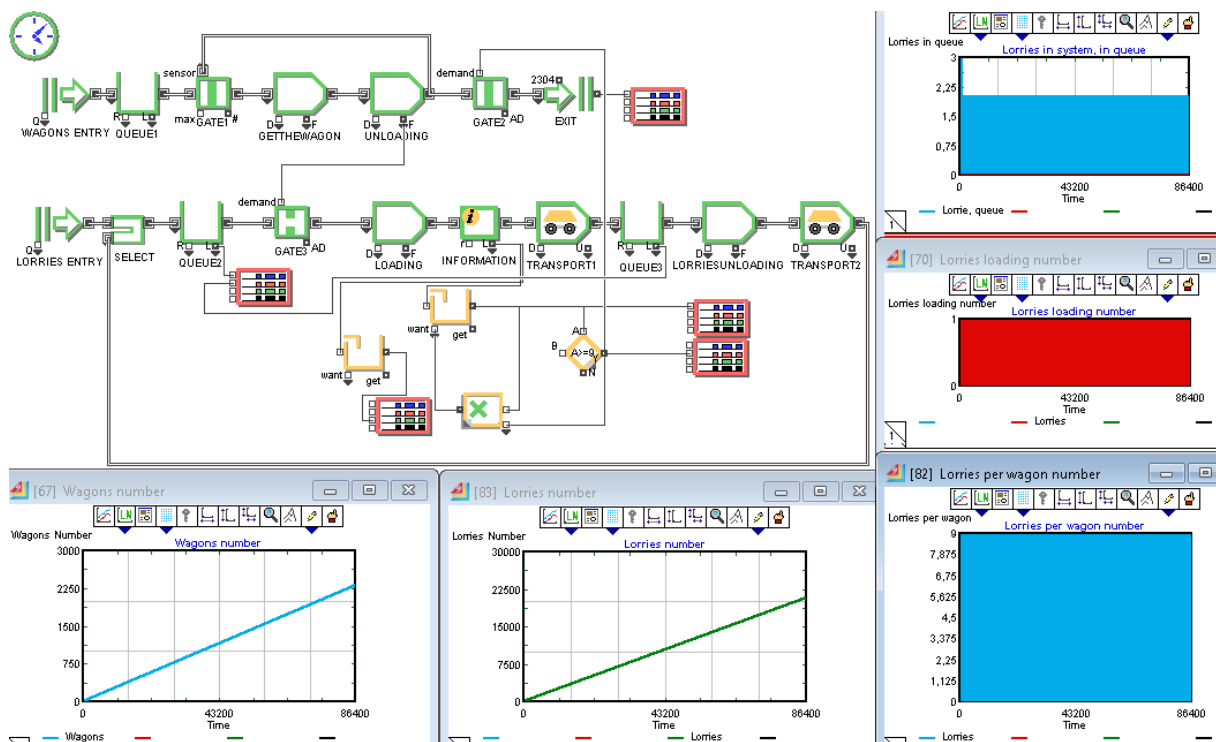

Fig. 16. The overall simulation model of the combined transport system for the transport of mineral resources.

**Acknowledgements:** The submitted paper is a part of the projects "Implementation of innovative instruments for increasing the quality of higher education in the 5.2.52 Industrial Engineering field of study" KEGA 030TUKE-4/2017, funded by the Slovak Cultural and Education Grant Agency and "The specific university research of Ministry of Education, Youth and Sports of the Czech Republic no. SP 2018/109 investigated at VSB-Technical University of Ostrava".

## References

- Besta P., Fialová V., Čech M. (2016): Inventory management in dynamic changes in the market environment, *Acta logistica*, 3(3), pp. 1-4., doi:10.22306/al.v3i3.62
- Botek M. (2005): Stimulative Tools in Firm's Management, *Manažment v teórii a praxi*, 1(1), pp. 34-40, 2005.
- Delgado Sobrino D.R., Košťál P., Cagaňová D., Čambál M. (2013): On the Possibilities of Intelligence Implementation in Manufacturing: the Role of Simulation, In: *Applied Mechanics and Materials: 3<sup>rd</sup> Central European Conference on Logistics (CECOL 2012), November 28-30, Trnava, Slovak Republic. Vol. 309*, pp. 96-104.
- Drastich A. (2017): Optimization of material flow by simulation methods, *Acta logistica* 4(4), pp. 23-26., doi:10.22306/al.v4i4.76
- Drejserska N. (2011): Przyszłość transportu w Europie - konieczność integracji polityk Unii Europejskiej, Future of transport in Europe – a necessity of integration of European Union policies, *Logistyka* 6(4), pp. 5165-5167.
- Duplákova D., Knapčíková L., Radchenko S., Hatala M. (2017): Software Support of Modelling using Ergonomic Tools in Engineering, *TEM Journal*, 6(3), 567-571, doi:10.18421/TEM63-18

- Folega P., Burchart-Korol D. (2017): Environmental assessment of road transport in a passenger car using the life cycle approach, *Transport Problems*, 12(2), pp. 147-153, doi:10.20858/tp.2017.12.2.14
- Grujic M., Malindzak D., Marasova D. (2011): Possibilities for reducing the negative impact of the number of conveyors in a coal transportation system, *Tehnicki Vjesnik-Technical Gazette*, 18(3), pp. 453-458.
- Hricová R. (2017): Situation on intermodal terminals in the Slovak Republic, *Acta logistica* 4(3), pp. 19-23. doi:10.22306/al.v4i3.51
- Khoury S., Cehlar M., Horansky K., Sandorova K. (2017): Expected Life Expectancy and its Determinants in Selected European Countries, *Transformations in Business & Economics*, 16(2B), pp. 638-655.
- Kiba-Janiak M. (2017): Urban freight transport in city strategic planning, *Research in Transportation Business & Management* 24, 4–16, doi:http://dx.doi.org/10.1016/j.rtbm.2017.05.003
- Malindzakova M., Straka M., Rosova A., Kanuchova M., Trebuna P.(2015): Modeling the process for incineration of municipal waste, *Przemysl Chemiczny*, 94(8), pp. 1260-1264, doi:10.15199/62.2015.8.4
- Pacana A., Bednářová L., Pacana J., Liberko I., Woźny A., Malindžák D. (2014): Effect of selected factors of the production process of stretch film for its resistance to puncture, *Przemysl Chemiczny*, 93(12), pp. 2263-2264, doi:10.12916/przemchem.2014.2263
- Saniuk A., Saniuk S., Cagaňová D., Čambál M. (2014): Control of strategy realization in metallurgical production, 23<sup>th</sup> International Conference on Metallurgy and Materials - METAL 2014, TANGER, Czech Republic, Brno, pp. 1876-1881.
- Straka M. (2015): Alfa, a.s. distribution logistics system, *Acta Montanistica Slovaca*, 15(SI 1), pp. 34-43, 2010.
- Straka M. (2017): The theoretical starting point of simulation-simulation system EXTENDSIM 9.x., Teoretické východiská simulácie-simulačný systém EXTENDSIM 9.x., *Technical University of Kosice, AMS-FBERG*, p. 99
- Straka M., Cehlar M., Khoury S., Trebuna P., Rosova A., Malindzakova M. (2016): Asbestos exposure and minimization of risks at its disposal by applying the principles of logistics, *Przemysl Chemiczny*, 95(5), pp. 963-970, doi:10.15199/62.2016.5.13
- Straka M., Lenort R., Khoury S., Feliks J. (2018): Design of large-scale logistics systems using computer simulation hierarchic structure, *International Journal of Simulation Modelling*, 17(1), pp. 105-118, doi:10.2507/IJSIMM17(1)422
- Straka M., Malindzak D. (2009): Algorithms of capacity balancing of printing machineries for Alfa Foils, a.s. planning system, *Acta Montanistica Slovaca*, 14(1), pp. 98-102.
- Straka M., Malindžáková M., Trebuňa P., Rosová A., Pekarčíková M., Fill M. (2017): Application of EXTENDSIM for improvement of production logistics' efficiency, *International Journal of Simulation Modelling*, 16(3), pp. 422-434. doi:10.2507/IJSIMM16(3)5.384
- Taušová M., Čulková K., Domaracká L., Drebenstedt C., Shejbalová Muchová M., Košč J., Behúnová A., Drevková M., Benčöová B. (2017): The importance of mining for socio-economic growth of the country, *Acta Montanistica Slovaca*, 22(4), pp. 359-367.
- Witkowski J., Kiba-Janiak M. (2012): Correlation between city logistics and quality of life as an assumption for a referential model, *Procedia – Social and Behavioral Sciences*, Edited by Eiichi Taniguchi and Russell G. Thompson, Seventh International Conference on City Logistics, June 7- 9, 2011, Mallorca, Spain, Elsevier, 39. 568-581, doi:https://doi.org/10.1016/j.sbspro.2012.03.131
- Wittenberger G., Cehlár M., Jurkasová Z. (2012): Deep hole drilling modern disintegration technologies in process of HDR technology, *Acta Montanistica Slovaca*, 17(4), pp. 241-246.
- Zemanová P., Botek M., Strachotová D. (2017): New management warehouse system design, In: *Proceedings of the 5th International Conference on Chemical Technology, April 10-12, 20217, Mikulov, Czech Republic*, pp. 191-196.